



2000 ELECTRICAL WINCH

20SPS12, 20SPS24, 20SPA12, 20SPA24

Assembly & Operating Instructions

CONTENTS

| | |
|--|-----------|
| INTRODUCTION..... | 1 |
| GETTING TO KNOW YOUR WINCH | 2 |
| SAFETY PRECAUTIONS..... | 3 |
| GENERAL TIPS FOR SAFE OPERATION | 5 |
| WINCHING TECHNIQUES A-Z | 6 |
| WINCH ASSEMBLY AND MOUNTING..... | 8 |
| MOUNTING DRAWING | 9 |
| WINCH ACCESSORIES YOU WILL NEED | 9 |
| RIGGING TECHNIQUES..... | 10 |
| WINCH WORKING DEMONSTRATION | 11 |
| REPLACING THE WIRE ROPE..... | 11 |
| MAINTENANCE | 12 |
| TROUBLE SHOOTING | 13 |
| WINCH ASSEMBLY DRAWING | 14 |
| WINCH PARTS LIST..... | 15 |
| SPECIFICATION | 16 |
| WARRANTY..... | 17 |

INTRODUCTION

Congratulations on your purchase of a high quality winch. We design and build winches to strict specifications and with proper use and maintenance should bring you years of satisfying service.

 WARNING - Read, study and follow all instructions before operating this device. Failure to heed these instructions may result in personal injury and/or property damage.

Your winch can develop tremendous pulling forces and if used unsafely or improperly could result in property damage, serious injury or death. Throughout this manual you will find the following symbols for caution, warning and danger. Pay particular attention to the notes preceded by these symbols as they are written for your safety. Ultimately, safe operation of this device rests with you, the operator.



This indicates a potentially hazardous situation, which if not avoided, may result in minor or moderate injury. This notation is also used to alert you against unsafe practices.



This indicates a potentially hazardous situation, which if not avoided, could result in death or serious injury.

GETTING TO KNOW YOUR WINCH

Your winch is a powerful piece of machinery. It is important that you understand the basics of its operation and specifications so that when you need to use it, you can use it with confidence and safety. Below is a list of the components of your winch and their use. You should practice using your winch before you are in a situation where you need to use it.

1. This winch is a development of a previous model which has been improved all over. The reducer, drum, clutch and the control units, have been skillfully improved resulting in a winch that is much stronger than ever.
2. Motor: Your 2.3/2.6hp motor is powered by a 12/24 volt battery and provides power to the gear mechanism which turns the drum and winds the wire rope.
3. Winch Drum: The winch drum is the cylinder on which the wire rope is stored. It can feed or wind the rope depending on the remote winch switch.
4. Wire Rope: Your winch has a 5/32"X49' galvanized aircraft cable designed specifically for load capacity of 2000lbs. The wire rope feeds onto the drum in the "under wind" position through the roller fairlead and is looped at the end to accept the clevis hook pin.
5. Roller Fairlead: When using the winch at an angle the roller fairlead acts to guide the wire rope onto the drum and minimizes damage to the wire rope from abrasion on the winch mount or bumper.
6. Mechanic Gear System: The reduction gears convert the winch motor power into extreme pulling forces.
7. Braking System: Braking action is automatically applied to the winch drum when the winch motor is stopped and there is a load on the wire rope. A separate mechanical brake applies the braking action.
8. Control System: Your winch was made to provide you with the ability to use it in a variety of operations. The winch can be controlled by using the Power Cord/Switch Assembly or through a solenoid control box.
9. Free Spooling Clutch: The clutch allows the operator to manually disengage ("CLUTCH OUT") the spooling drum from the gear train enabling free spool. Engaging the clutch ("CLUTCH IN") locks the winch into the gear system.

10. Solenoid: Power from the vehicle battery flows through the weather-sealed switch before being directed to the winch motor.
11. Remote Switch: The Power switch leads have a dual switch for powering in or powering out your winch drum. The Power switch leads allow you to stand clear of the wire rope when the winch is under load.
12. Wireless Remote Control: has a range of up to 50 Ft.
13. Universal Flat Bed Mounting Channel: Your winch may have the option of a flatbed mounting channel that can be mounted to most flat surfaces such as trailers, step bumpers, truck beds, etc. The mounting channel also has holes to accept your roller fairlead.
14. Snatch Block: Your winch may be supplied with a snatch block that can double the pulling power of the winch, or change the pulling direction without damaging the wire rope. We recommend you use double line and snatch block for pulling over 70% of the rated line pull.

SAFETY PRECAUTIONS

WARNING

 **WARNING** –Do not exceed rated capacity shown in this table.

| Layer | Rated line pull lbs (kgs) | Total rope on the drum ft (m) |
|-------|---------------------------|-------------------------------|
| 1 | 2000(907) | 6.6(2.0) |
| 2 | 1630(739) | 14.1(4.3) |
| 3 | 1380(626) | 22.3(6.8) |
| 4 | 1190(540) | 31.2(9.5) |
| 5 | 1050(476) | 41.0(12.5) |
| 6 | 940(426) | 49.0(15.0) |

 **WARNING** – Intermittent use only. Allow winch to cool between uses.

 **WARNING** – Do not use winch to lift (vertically).

 **WARNING** – Do not use winch to pull or move people in any way.

 **WARNING** – NEVER cut, weld, or modify any part of the winch or cable.

 **WARNING** – A minimum of five wraps of cable around the drum barrel is necessary for pulling and holding the rated load.

 **WARNING** – Keep yourself and others a safe distance to the side of the cable when it is under tension.

 **WARNING** – The wire rope may break before the motor stalls. For heavy loads at or near rated capacity, use a pulley block/snatch block to reduce the load on the wire rope.

 **WARNING** – Never step over a cable, or go near a cable under load.

 **WARNING** – Don't move the vehicle to pull a load (towing) on the winch cable. This could result in cable breakage.

 **WARNING** – Disconnect the remote control and battery leads when not in use.

 **WARNING** – Avoid “shock loads” by using the control switch intermittently to take up the slack in the wire rope. “Shock loads” can far exceed the rate capacity for the wire rope and drum.

 **WARNING** – Do not exceeds maximum line pull ratings shown on the tables.

 **WARNING** – When re-spooling the cable, ensure that the cable spools in the under-wind position with the cable entering the drum from the bottom, not the top. To spool correctly you should keep a slight load on the cable while pushing the remote button to draw in the cable. Walk toward the winch not allowing the cable to slide through your hands. Do not let your hands get within 12 " of the winch while re-spooling. Turn off the winch and repeat the procedure until a few feet of cable is left. Disconnect the remote control and finish spooling by hand by rotating the drum by hand with the clutch disengaged. Keep hands clear of the fairlead and drum while the winch is under power.

 **Do not use as a hoist. Do not use for overhead lifting.**

 Failure to heed these warnings may result in personal injury and/or property damage.

 **WARNING** – Use gloves to protect hands when handling the cable. Never let the cable slide through your hands.

 **WARNING** – Never connect the cable back to itself. Apply blocks to the wheels of the vehicle when on an incline. Duration of winching pulls should be kept as short as possible. If the motor becomes uncomfortably hot to the touch, stop winching immediately and let it cool down for a few minutes. Do not pull for more than one minute at or near the rated load.

 **CAUTION** – If the motor stalls do not maintain power to the winch. Electric winches are designed and made for intermittent use and should not be used in constant duty applications.

 **CAUTION** – Never disengage the clutch when there is a load on the winch.

 **CAUTION** – Use the hand saver hook when handling the hook for spooling or un-spooling the wire rope.

GENERAL TIPS FOR SAFE OPERATION

- The 2,000lbs and its all-derivative types are rated at 2,000 lbs capacity when spooling the first rope layer on the drum. Overloading can damage the winch/motor/ or wire rope. For loads over 70% of rated line pull, we recommend the use of the pulley block/snatch block to double the wire rope line. This will aid in two ways: a) reduce the number of rope layers on the drum, b) reduce the load on the wire rope by as much as 50%. When doubling the line back to the vehicle, attach to the frame or other load bearing part.
- The vehicle engine should be kept running during operation of the winch to minimize battery drain and maximize power and speed of the winch. If the winch is used for a considerable amount of time with the engine off, the battery may be drained and too weak to restart the engine.
- Get to know your winch before you actually need to use it. We recommend that you set up a few test runs to familiarize yourself with rigging techniques, the sounds your winch makes under various loads, the way the cable spools on the drum, etc.

- Inspect the wire rope and equipment before each use. A frayed or damaged rope must be replaced immediately. Use only the manufacturer's replacement rope with the exact specifications.
- Inspect the winch installation and bolts to ensure that all bolts are tight before each operation.
- Never connect the cable back to itself. This will cause cable damage. Always use a snatch block, sling or chain of suitable strength as shown in the illustrations.
- Store the remote control inside your vehicle in a place that it will not be damaged.
- Any winch that appears to be damaged in any way, is found to be worn, or operates abnormally shall be removed from service.
- Pull only on parts of the vehicle as specified by the vehicle manufacturer.
- Only attachments and/or adapters supplied by the manufacturer shall be used.
- Before installing your winch it is recommended to perform a test run in both directions for only a couple of rotations of the drum. It is good practice to ensure that the clutch is dis-engaged when not under load or in use.

WINCHING TECHNIQUES A-Z

- a. Take time to assess the situation and surroundings before operation of the winch.
- b. Put on gloves to protect your hands.
- c. Disengage the clutch to allow free-spooling and to save energy.
- d. Attach the hand saver hook to the clevis hook to protect your skin.
- e. Pull out the wire rope to your desired anchor point using the hand saver hook.
- f. Secure the clevis hook to the anchor point. Do not attach the hook back onto the wire rope.
- g. Engage the clutch.
- h. Connect the remote control to the winch.
- i. Start your engine to ensure power is being replenished to the battery.
- j. Power in the wire rope guiding the wire under tension to draw up the slack in the wire. Once the wire is under tension stand well clear. Never step over the wire rope.
- k. Double-check your anchors and make sure all connections are secure.

- l. Inspect the wire rope. Make sure there are at least 5 wraps of wire rope around the winch drum.
- m. Drape a winch sail (recommended), blanket or jacket over the wire rope approximately 5 to 6 feet from the hook. Open the vehicle bonnet if possible for added protection.
- n. Clear the area. Make sure all spectators are back and that no one is directly in front or behind the vehicle or anchor point.
- o. Begin winching. Be sure that the wire rope is winding evenly and tightly around the drum. The vehicle that is being winched can be slowly driven to add assistance to the winching process. Avoid shock loads; keep the wire rope under tension.
- p. The vehicle to be winched should be placed in neutral and the emergency brake released. Only release the brake pedal when under full tension. Avoid shock loads to the winch. This can damage the winch, rope and vehicle.
- q. The winch is meant for intermittent use. Under full load with a single line rig do not power in for more than a minute without letting the motor cool down for a few minutes and then resume the winching operation.
- r. The winching operation is complete once the vehicle is on stable ground and is able to drive under its own power.
- s. Secure the vehicle. Be sure to set the brakes and place the vehicle in park.
- t. Release the tension on the wire rope. The winch is not meant to hold the vehicle for long periods of time.
- u. Disconnect the wire rope from the anchor.
- v. Rewind the wire rope. Make sure that any wire already on the drum has spooled tightly and neatly. If not, draw out the wire and re-spool from the point where the rope is tight.
- w. Keep your hands clear of the winch drum and fairlead as the wire rope is being drawn in.
- x. Secure the hook and hook strap.
- y. Disconnect the remote control and store in a clean, dry place.
- z. Clean and inspect connections and mounting hardware for next winching operation.

WINCH ASSEMBLY AND MOUNTING

1. Your 2000lb winch is designed with a bolt pattern that is standard in this class of winch. Many winch mounting kits are available that utilize this bolt pattern for the popular ATV's and mounting channels. If you will utilize the mounting channel you must ensure that it is mounted on a flat surface so that the three major sections (motor, drum and gear housing) are properly aligned. Proper alignment of the winch will allow even distribution of the full rated load.
2. Start by connecting the roller fairlead (Part# K200700) to the mounting channel (Part# K200022) using 2 each of the cap screw M8 X 20 (Part# K200023), flat washer (Part# K200021), lock washer (Part# K200020) and securing with Nut M8 (Part# K200019) (Make sure the screw is placed through the mounting channel and roller fairlead from inside the channel. This will allow enough clearance for the winch to be placed in the channel without obstruction.)
3. Assemble the winch to the mounting channel (Part# K200022) by first pulling and releasing the clutch knob to the "CLUTCH OUT" position (Free Spooling). Pull out a few inches of cable from the drum and feed the wire loop through the opening in the front of the mounting channel and roller fairlead. Now, using the remaining M8 x 35 cap screws (Part# K200024), flat washer (Part# K200021), lock washer (Part# K200020) and nut M8 (Part# K200019) secure the winch to the mounting channel.
4. Connect the battery and motor leads as per diagram below. Keep in mind that every type of winch is different.



CAUTION – Batteries contain gases which are flammable and explosive. Wear eye protection during installation and remove all jewelry. Do not lean over battery while making connections.

5. Assemble the clevis hook to the cable. Take off the pin from the clevis hook, connect the clevis hook to the cable and mount the pin back to the clevis hook.
6. Always use the hand saver when free-spooling and re-spooling the wire rope. Using the hand saver keeps your hands and fingers away from the rotating drum.
7. Check for proper drum rotation. Pull and turn the clutch knob to the "CLUTCH OUT" position. Pull out some cable from the drum, and then turn the clutch knob to the "CLUTCH IN" position to engage the gears. To test your remote control, press the out button on the remote control. If the drum turns and releases more cable, then your connections are accurate. If the drum is winding in, then reverse the leads on the motor. Repeat and check rotation.

MOUNTING DRAWING

The mounting drawing

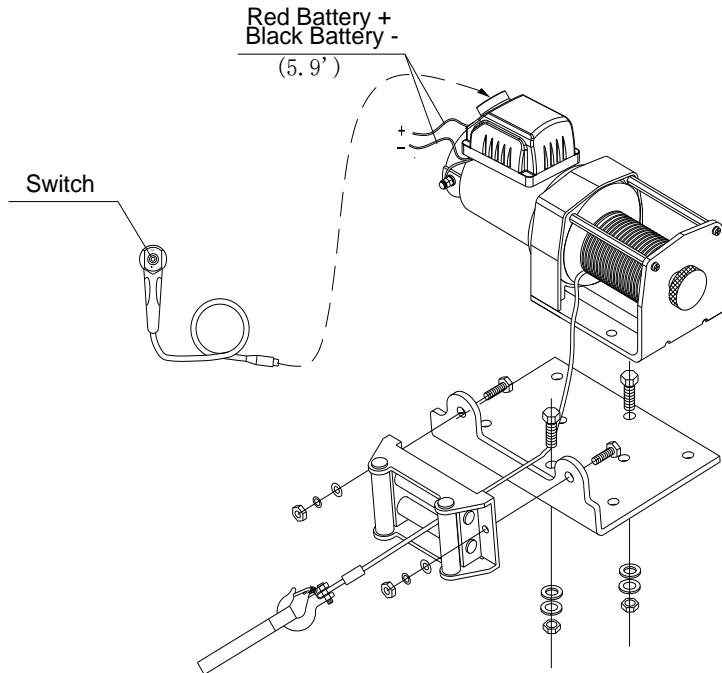

WINCH ACCESSORIES YOU WILL NEED

NOT INCLUDED WITH YOUR WINCH

Gloves – For handling the wire rope and hook strap.

Anchor Strap/Chain – Tree saver anchor straps are made of high quality nylon with high tensile strengths from 5,000lbs to 10,000lbs.

Heavy Blanket – place on the cable to absorb energy should the wire rope break.

RIGGING TECHNIQUES

Self-Recovery

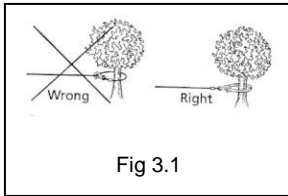

Locate a suitable anchor such as a strong tree trunk or boulder.

Always use a sling as an anchor point. **⚠ CAUTION** Do not attach the clevis hook back onto the cable as this could cause damage to the cable. As shown in Fig 3.1

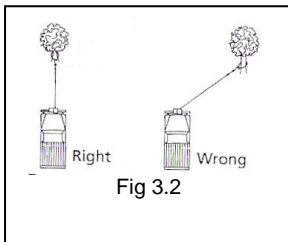

⚠ CAUTION Do not winch from an acute angle as the wire rope will pile up on one side of the drum causing damage to wire rope and the winch. Fig 3.2

Short pulls from an angle can be used to straighten the vehicle. Long pulls should be done with the wire rope at a 90° angle to the winch/vehicle.

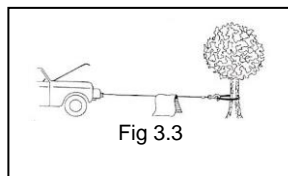

When pulling a heavy load, place a blanket or jacket over the wire rope five or six feet from the hook. In the event of a broken cable it will dampen the snap back. For additional protection open the hood of the vehicle as shown in Fig 3.3

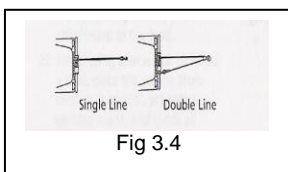

For pulls over 70% rated line pull, we recommend the use of the snatch block/pulley block to double line the wire rope. Fig 3.4

This reduces the load on the winch and the strain on the rope by up to 50% depending on the included angle.

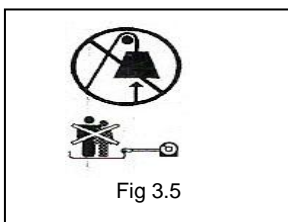

⚠ WARNING - Never use your winch for overhead hoisting or for lifting people or moving people.

WINCH WORKING DEMONSTRATION

1. Disengage the clutch by turning the clutch to the “CLUTCH OUT” position.
2. Grab the cable (Part# K200015) and pull the cable to the desired length, then attach to item being pulled.

⚠ CAUTION: Always leave at least five turns of cable on the drum; Review winch safety warnings and precautions on page 2、 3 before continuing.

3. Reengage the clutch by turn the clutch handle (Part# K200015) to the “CLUTCH IN” position, if the clutch is not engaged, the winch drum must be turned by hand, until the clutch is totally engaged.
4. Insert the switch assembly (Part# K200600) connector onto the control box.
5. Test-run winch in two directions for at least two seconds.
6. Stand away for safety from the towing pathway. Hold and operate the remote control supplied. Wait until the motor stops before reversing directions.
7. When pulling is complete, remove the switch assembly-remote control (Part# K200600). To do this remove the socket from winch and replace the protective cap. .

REPLACING THE WIRE ROPE

If the wire rope has become worn or is beginning to show signs of strands breaking, it must be replaced before being used again.

1. Turn clutch to the “CLUTCH OUT” position.
2. Free spool cable from the drum using gloves. Take note how the existing cable is connected to the drum.
3. Remove old cable assembly and attach new one in the same way as the old one was connected and secure the screw M5x8 (Part# K200005).
4. Ensure that the new cable wraps in the same rotation direction as the old one. The cable should leave the drum from the bottom, under the drum.
5. Turn clutch to the “CLUTCH IN” position.

6. Safely rewind cable onto the drum (for the first five wraps be careful not to allow kinking). Cable must be wound onto the drum under a load of at least 10% rated line pull.

 **WARNING** - Only replace the wire rope with the identical replacement part recommended by the manufacturer.

MAINTENANCE

1. Periodically check the tightness of mounting bolts and electrical connections. Remove all dirt or corrosion and always keep clean.
2. Do not attempt to disassemble the gear box.
3. The gearbox has been lubricated using a high temperature lithium grease and is sealed at the factory. No internal lubrication is required.

TROUBLE SHOOTING

| SYMPTOM | POSSIBLE CAUSE | SUGGESTED ACTION |
|---|---|--|
| Motor does not turn on | <ul style="list-style-type: none"> -Switch Assembly not connected properly -Loose battery cable connections -Defective Switch Assembly -Defective motor -Water has entered motor | <ul style="list-style-type: none"> -Insert Switch Assembly all the way into the connector. -Tighten nuts on all cable connections. -Replace Switch Assembly. -Check for voltage at armature port with Switch pressed. If voltage is present, replace motor. -Allow to drain and dry. Run in short bursts without load until completely dry. |
| Motor runs but cable drum does not turn | <ul style="list-style-type: none"> -Clutch not engaged | <ul style="list-style-type: none"> -Turn clutch to the "In" position. If problem persists, a qualified technician needs to check and repair. |
| Motor runs slowly or without normal power | <ul style="list-style-type: none"> -Insufficient current or voltage | <ul style="list-style-type: none"> -Battery weak recharge. Run winch with vehicle motor running. -Loose or corroded battery cable connections. Clean, tighten, or replace. |
| Motor overheating | <ul style="list-style-type: none"> -Winch running time too long | <ul style="list-style-type: none"> -Allow winch to cool down periodically. |
| Motor runs in one direction only | <ul style="list-style-type: none"> -Defective Switch Assembly | <ul style="list-style-type: none"> -Loose or corroded battery cable or motor cable connections. Clean and tighten. -Repair or replace switch assembly. |

WINCH ASSEMBLY DRAWING

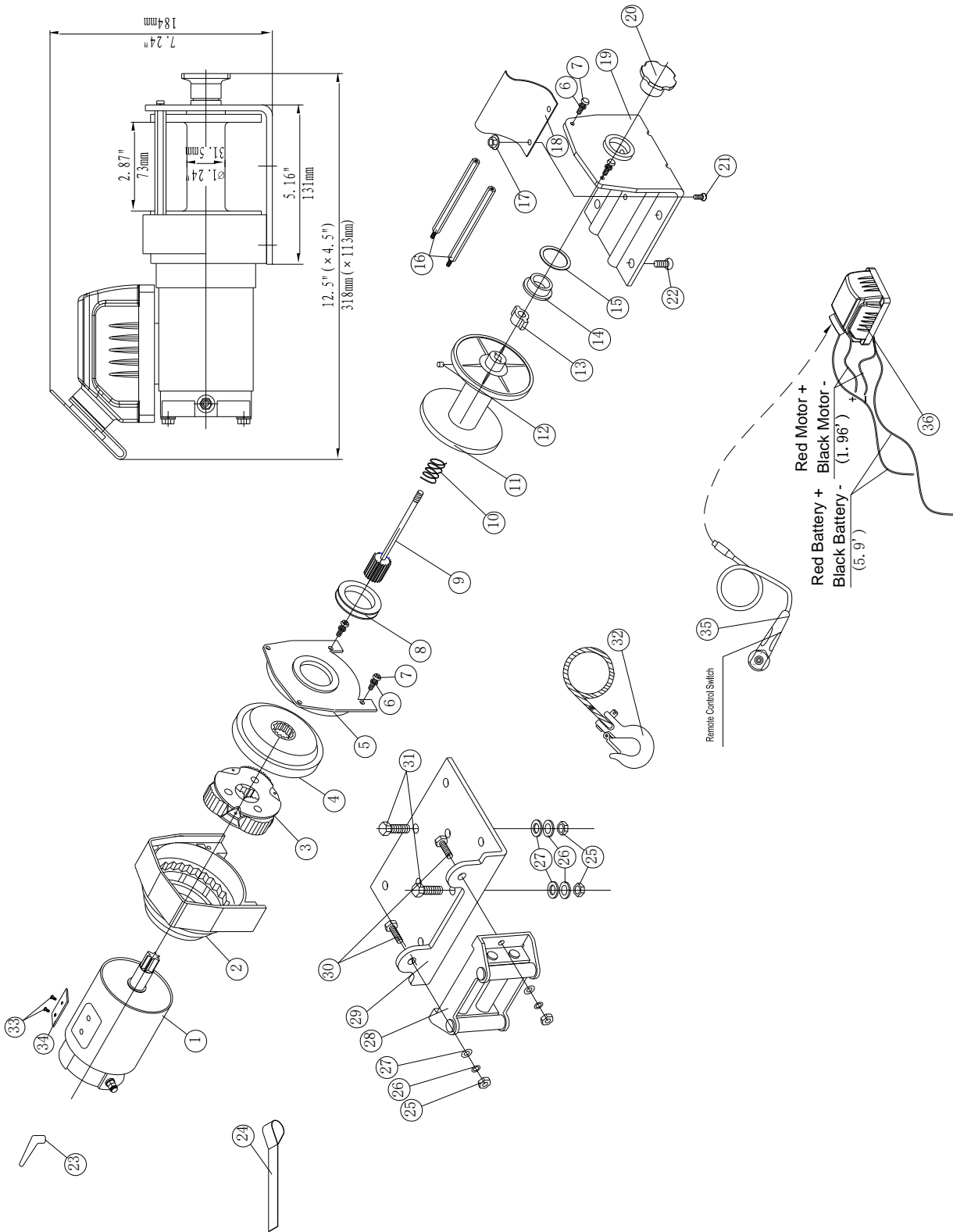

WINCH PARTS LIST

| No. | Part # | Qty | Description | Remark |
|-----|-----------|-----|---------------------------------------|--|
| 1 | K200100-U | 1 | Motor Assembly | |
| 2 | K200200 | 1 | Gear-Box Assembly | |
| 3 | K200300 | 1 | Planetary Gear Assembly | |
| 4 | K200400 | 1 | Output Gear Ring Assembly | |
| 5 | K200001 | 1 | Drum Holder Plate | |
| 6 | K200002 | 4 | Locking Washer ϕ 5 | |
| 7 | K200003 | 4 | Hexagon Socket Head Cap Screw M5 x 12 | |
| 8 | K200004 | 1 | Bush (I) | |
| 9 | K200500 | 1 | Clutch Assembly | |
| 10 | K200005 | 1 | Spring | |
| 11 | K200006 | 1 | Drum | |
| 12 | K200007 | 1 | Screw M5 x 8 | |
| 13 | K200008 | 1 | Separation And Reunion Cake | |
| 14 | K200009 | 1 | Bush (II) | |
| 15 | K200010 | 0-2 | Adjustive Washer | |
| 16 | K200011 | 2 | Tie Bar | |
| 17 | K200012 | 2 | Hex Flange Nut M5 | |
| 18 | K200013 | 1 | Tension Plate | |
| 19 | K200014 | 1 | Base Plate | |
| 20 | K200015 | 1 | Clutch Handle | |
| 21 | K200016 | 2 | Screw M5 x 10 | |
| 22 | K200017 | 2 | Hex Fh Screw M6 x 16 | |
| 23 | K200018 | 2 | Terminal Protector | |
| 24 | K200025 | 1 | Strap | |
| 25 | K200019 | 4 | Hex Flange Nut M8 | |
| 26 | K200020 | 4 | Locking Washer Φ 8 | |
| 27 | K200021 | 4 | Thick Flat Washer Φ 8 | |
| 28 | K200700 | 1 | Roller Fairlead | |
| 29 | K200022 | 1 | Mounting Channel | |
| 30 | K200023 | 2 | Cap Screw M8 x 20 | |
| 31 | K200024 | 2 | Cap Screw M8 x 35 | |
| 32 | K200800 | 1 | Cable Assembly | SYNTHETIC ROPE 4MM X 15M BY CHOICE |
| 33 | K200026 | 2 | Screw M5 x 6 | |
| 34 | K200027 | 1 | Control Box Fixing Panel | |
| 35 | K200600-U | 1 | Remote Control Switch (RC3) | |
| 36 | K201200-U | 1 | U Type Control Box | |

SPECIFICATION

| | |
|-----------------------------------|---|
| Rated line pull | 2000 lbs (907 kgs) |
| Motor: permanent magnet | 12V:0.8hp / 0.6 kw 24V:0.9hp / 0.7 kw |
| Gear reduction ratio | 153:1 |
| Cable (Dia. × L) | Ø5/32" × 49' (Ø4mm × 15m) |
| Drum size (Dia. × L) | Ø1.24" × 2.87" (Ø31.5mm × 73 mm) |
| Mounting bolt pattern | 3.13" (79.5 mm) ;2-M8 |
| ITEM | 20SPS 20SPA |
| Overall dimensions (L × W × H) | 12.5" × 4.5" × 7.24" 318mm × 113mm × 184mm |
| Net weight lbs(kg) | 15 6.8 |

Pull, Speed, Amperes, Volts (First layer):

| Line Pull lbs (kgs) | Line Speed ft/min (m/min) | | Current A | |
|------------------------|---------------------------|-----------|-----------|--------|
| | 12V DC | 24V DC | 12V DC | 24V DC |
| 0 | 10.5(3.2) | 11.8(3.6) | 15 | 12 |
| 500(227) | 9.2(2.8) | 10.2(3.1) | 25 | 10 |
| 1000(454) | 7.5(2.3) | 8.5(2.6) | 40 | 15 |
| 1500(680) | 5.9(1.8) | 6.9(2.1) | 60 | 25 |
| 2000(907) | 3.3(1.0) | 3.6(1.1) | 90 | 55 |

Line Pull And Rope Capacity In Layer

| Layer | Rated line pull lbs (kgs) | Total rope on the drum ft (m) |
|-------|---------------------------|-------------------------------|
| 1 | 2000(907) | 6.6(2.0) |
| 2 | 1630(739) | 14.1(4.3) |
| 3 | 1380(626) | 22.3(6.8) |
| 4 | 1190(540) | 31.2(9.5) |
| 5 | 1050(476) | 41.0(12.5) |
| 6 | 940(426) | 49.0(15.0) |

WARRANTY

Your winch has been manufactured and tested to the highest standards. Please ensure you read and understand the assembly and operating instructions before use. Failure to comply with these instructions or any improper use of the equipment will terminate the warranty.

Please ensure you record the information below:

| | |
|-------------------------|--|
| Distributor | |
| Date of Purchase | |
| Invoice No | |
| Serial No | |

In the unlikely event you experience problems, contact the distributor with this information.

Limited lifetime with 3 year on electrical

Limited Lifetime Warranty for WARRIOR WINCHES

Winch solutions are the sole distributors of WARRIOR WINCHES.

Winch solutions ("seller" or winch solutions) warrants to the original retail buyer only ("Buyer") that any mechanical component of a genuine WARRIOR WINCH ("product") is free of defects in material and workmanship for the lifetime of the winch.

The electrical components (including the motor, contactor, and switches) will be free of defects in material and workmanship for a period of (3) three years (36 Months) from the original purchase provable date of purchase.

Any Product Winch solutions determines to be defective will be repaired or replaced at Winch solutions sole discretion without charge to the Buyer upon Buyer's compliance with this procedure. Seller or its Authorized Agent may make reasonable charges for parts and for labour for repairs not covered by this Lifetime Limited Warranty. The warranties set forth herein are exclusive and in lieu of all other warranties, whether oral or written, express or implied.

All purchases must be registered. Any product that has not been registered will be covered by the standard 1 year warranty.

To obtain service under this warranty, the Buyer shall mail, ship or otherwise deliver to the address noted below, at the Buyers expense; (1) the Product, (2) a written description of the problem, (3) Buyers name, address and contact number, (4) copy of the original purchase receipt.

The Warranty does not cover the cost of labour or transportation/shipping charges for the replacement or installation of defective parts.

This warranty does not apply to defects of the Product caused by; (1) normal wear and tear, (2) failure to comply with any installation or maintenance instructions provided by the Seller, including but not limited to subjecting the product to loads in excess of the loads listed in any instructions, Owners Manual or as detailed upon the Sellers website, (3) commercial or industrial use, (4) alteration or modification by any parties other than the Seller, (5) misuse, abuse, neglect, accidents, Acts of God, terrorism or (6) other causes beyond the control of the Seller after delivery of the Product to the Sellers Authorized Agent.

This Warranty does not cover cables, synthetic ropes, fairleads or exterior finishes

Winch solutions shall not be responsible or liable for any indirect or consequential damages. These consequential damages may include, but are not limited to, lost profits or loss of use and down time.

A winch solution reserves the right to change the Product design without notice. A winch solution reserves the right to replace any part or whole unit with a newer design of the same function.

Please ensure you record the information below:

| | |
|-------------------------|--|
| Distributor | |
| Date of Purchase | |
| Invoice No | |
| Serial No | |

Please register your Winch at www.warriorwinch.co.uk , any product that is not registered will not be covered by the lifetime warranty.

In the unlikely event you experience problems, contact the distributor with this information.